

PLAN.

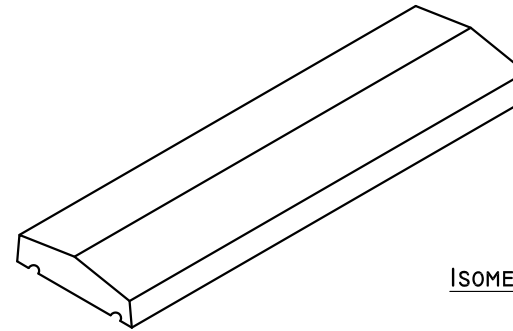

ISOMETRIC VIEW.

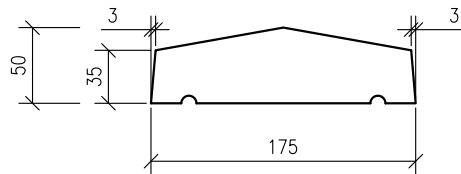

END VIEW.

C-35 concrete @ 28 days with 10mm & 14mm aggregate used in the manufacture of this unit.

No steel reinforcing.

- DO NOT SCALE USE FIGURED DIMENSIONS ONLY.
- ALL DIMENSIONS TO BE CHECKED ON SITE.
- A.P.C TO BE INFORMED OF ANY DISCREPANCIES BEFORE WORK PROCEEDS.

© COPYRIGHT: Ardee Precast Concrete.
This drawing or any part thereof may not be copied or otherwise reproduced without the written permission of Ardee Precast Concrete.

Project:

TECHNICAL DATA SHEET.

Sheet Size:

A4

Title:

**COPINGS - TYPE 4.
175MM WIDE.**

Drawing Scale:

1:10, 1:5

Drawn By:

N.D.

Drawing No:

APC - 603

Revision:

Date:

07-10-2011

Checked By:



Ardee Precast Concrete Ltd.

Townparks
Ardee
Co. Louth

Tel. +353(0)41 6856372
Fax. +353(0)41 6857216

Email us at info@ardeeprecastconcrete.com
Visit us at www.ardeeprecastconcrete.com